

LEEANN CELLULAR AND PLEATED SHADES

GB Lift Installation Instructions

Please note that the GB Lift mechanism should not be operated prior to the shade's installation. Before proceeding with installation, please note that for proper shade support, clips and brackets should not be mounted more than 48" apart. Outer supports should be approximately two inches from the end of the headrail. Please use wood screws or appropriate fasteners for other surfaces. Position the shade at the window to determine the location of supports. Then, follow the installation procedure specific to the shade support system enclosed with your shade and the type of mounting required.

Inside or Ceiling Mount

Place screws through top of bracket and secure to casing or ceiling (I-1). Attach shade to brackets by placing front edge of headrail into the front bracket lip (I-2). Push back of headrail up into the back of the bracket lip until headrail snaps securely into place (I-3).

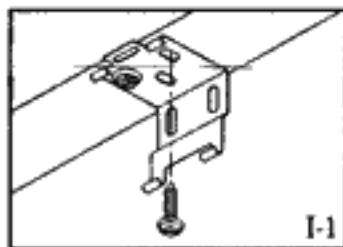

I-1

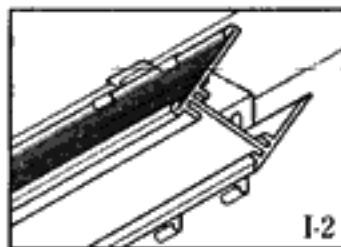

I-2

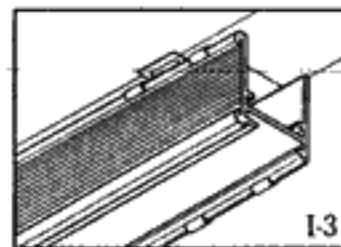

I-3

Outside or Wall Mount

Place screws through back of bracket and secure to wall or frame (J-1). Attach shade to bracket by placing front edge of headrail into front bracket lip (J-2). Push back of headrail up into the back of the bracket lip until headrail snaps securely into place (J-3).

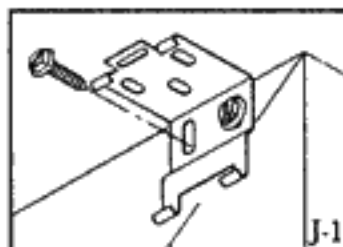

J-1

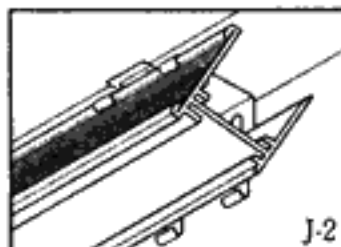

J-2

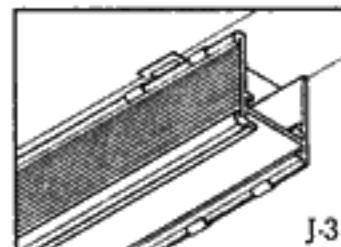

J-3

Projection Mount

Attach angular supports to wall or frame. Two supports are needed for each bracket (K-1). Attach the bracket, placing screws through the top of the bracket and through the angular support (K-2). Attach shade to bracket by placing front edge of headrail into front bracket lip (K-3). Push back of headrail up into the back of the bracket until headrail snaps securely into place (K-4).

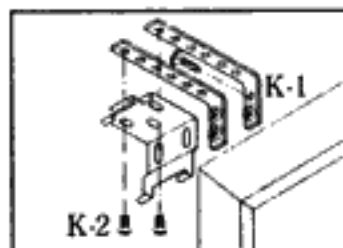

K-1

K-2

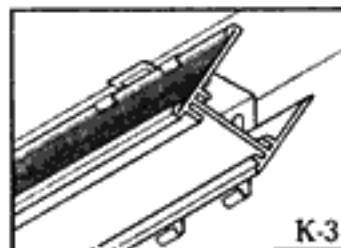

K-3

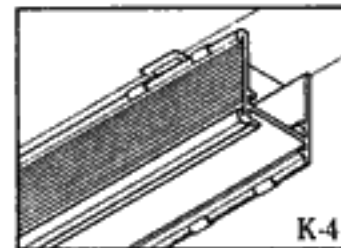

K-4

Thank you for choosing Prestige® Pleated Shades. With proper installation and care, your new shades will provide many years of beauty and performance.

To install any of these shades, you will need a few simple tools:

- Measuring Tape
- Power Drill and Drill Bits
- Long Flat Blade Screwdriver
- Phillips Screwdriver

Expansion or toggle bolts are required with non-solid surfaces, such as drywall or lath and plaster.

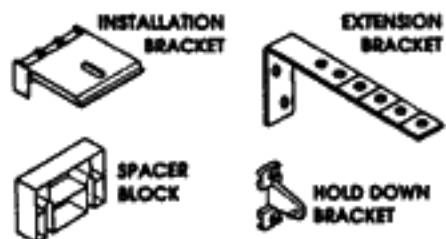

Installation brackets are attached either inside or outside the window well, depending upon whether the shade was ordered as an *inside mount* or an *outside mount*. In addition to the installation brackets, other components may be needed to install your Prestige® specialty pleated shades. For example, on outside mount applications, spacer blocks or extension brackets are often used with the installation brackets to allow the shade to clear obstructions. Hold down brackets are optional installment components. They are used to prevent the bottom of the shade from swaying. The installation hardware you received with your pleated shades was specified at the time the shades were ordered, based upon your particular installation needs.

The installation is organized into easy steps. Before you begin, however, please completely read these instructions to acquaint yourself with all the procedures.

• INSTALLING BRACKETS •

BRACKET SPACING

Bracket spacing is the same for both inside and outside mounts. Two installation brackets are positioned so that their centerlines are 3" from the ends of the shades. If more than two brackets are required, additional brackets are spaced evenly between the two end brackets. Measure and mark all bracket centerlines.



INSIDE MOUNT APPLICATIONS

To inside mount a Prestige® Pleated shade, attach the tops of the installation brackets to the top sill of the window opening. To fully recess the shade, the flat surface of the sill must be at least 1-1/2" deep. Add to this minimum depth requirement the dimension of any obstruction to shade movement, such as a window crank or handle.

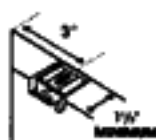

Only one screw is needed to attach each bracket in inside mount applications. Locate the screws on the centerlines you marked and attach the brackets so that their front edges are aligned.

OUTSIDE MOUNT APPLICATIONS

Mount the ends of the installation brackets on a flat vertical surface at least 5/8" high. Two screws are used to attach each bracket. Position the brackets on the centerlines you marked and attach them with the appropriate fasteners. The tops of the installation brackets must be on the same level and parallel to the top of the window opening.



SPACER BLOCKS

Spacer Blocks are used to project the installation bracket away from the mounting surface when additional shade clearance is needed. Use a maximum of three blocks, with the solid sides facing the mounting surface. Check to be sure your mounting screws are long enough for a secure installation.

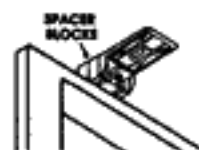

EXTENSION BRACKETS

Extension brackets can project the installation brackets up to 2-1/2" from the mounting surface. Position the brackets on the centerlines you marked and use two screws to attach them. Align the tops of the brackets on the same level. For angled-top shades align the tops of the bracket parallel to the sloped top of the window opening. Connect the installation brackets with the machine screw and speed nut which are included with each extension bracket. Be sure to use the same hole on all the extension brackets so that each installation bracket projects the same distance from the mounting surface.



Indentations are cast into the extension bracket between each hole. If desired, an unneeded length of the bracket may be cut off. This should be done before mounting the extension bracket.

• INSTALLING THE SHADE •

Unwind the cord from around the shade assembly and let it hang. With the cordlock facing you, slip the headrail into the installation brackets. The front lips on the brackets fit into the front groove on the top of the rail. Push on the rail until it snaps into place.

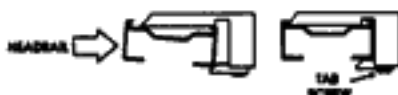

After making sure that no fabric is trapped between the headrail and the tabs on the installation brackets, use a screwdriver to tighten the tab screw on each bracket until it is just snug. Do not over tighten.

OPTIONAL HOLD DOWN BRACKETS

With the shade at its full drop, place the pin on each of the two hold down brackets into the bottom rail end caps and mark mounting hole locations. Attach the hold down brackets with one screw through the side hole or two screws through the end holes. Be sure the bracket pins are aligned and level.

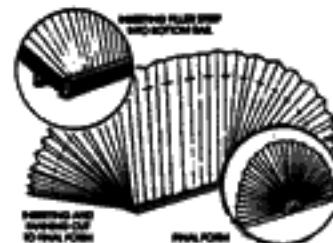
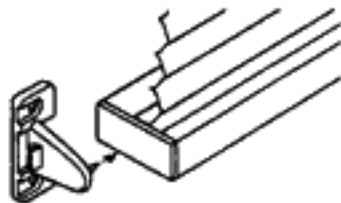

INSTALLATIONS USING SPECIALTY END MOUNT BRACKETS

Insert brackets into the small grooves on the rail. With an arch over a standard shade, pull the cordlock out about 1/2" and slide the arch down to fit the bracket into the grooves. Push the bracket and cordlock into the rail, as shown, and recenter the arch. On the other end of the rail, install the bracket over the end cap.



When specialty end mount brackets are used with a stand-alone arch, the bracket ends point up toward the top of the arch, instead of down.

Hold the shade assembly in the window opening and mark where to install the mounting bracket screws. Use a level to make sure the rail is properly aligned. To fully recess the arch, the window opening must be at least 1-1/4" deep.

INSTALLATIONS USING SPECIALTY WALL MOUNT BRACKETS

Connect the brackets to the mounting surface. You will need a flat vertical surface at least 1-3/4" wide by 7/8" high for each bracket. Position two installation brackets so that their outside edges are 1-1/2" in from the ends of the shades. If the shade is wide enough to require more than two installation brackets, space additional brackets evenly between the two end brackets.

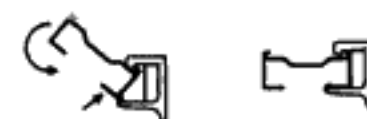

To install an arch over a standard shade into the specialty wall mount bracket, tilt the arch away from you and slip the top edge of the rail into the top lip of the bracket. Then push the rail down and in to lock it into the lower lip of the bracket, as shown. For stand-alone arches, mount the bracket upside-down and change the installation accordingly.

INSTALL ARCH SUPPORT CLIPS

Arch support clips can be used with either inside or outside mounts. Mount an arch support clip at the top of the arch, so that the clip holds the pleat of the fabric, as shown. If necessary, space additional clips evenly along the arch so that the clips are spaced at least every 10 pleats.



INSTALLATION INSTRUCTIONS FOR SPECIALTY PLEATED ARCH SHADES

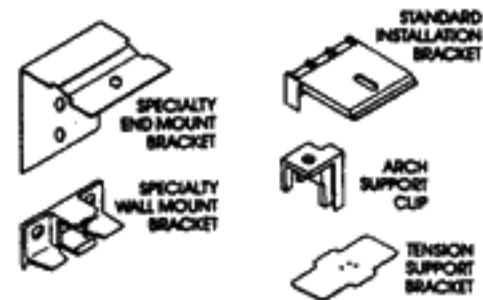

Mounting brackets are attached either inside or outside the window well, depending upon whether the shade was ordered as an *inside mount* or an *outside mount*. There are three types of mounting brackets. *Specialty end mount brackets* are used with inside mount installations and *specialty wall mount brackets* are used with outside mounts. These brackets can be used when the arch shares the headrail with a standard pleated shade, as well as when the arch stands alone. *Standard installation brackets* can be used with either inside or outside mounts on stand-alone arches only. Other installation components include *arch support clips*, which help support the fabric in quarter-circle and half-circle arches, and are used to mount circular shades. The installation components you received with your Prestige® pleated shades were specified at the time the shades were ordered, based upon your particular installation needs.

• ARCH TOPS •

INSTALL FABRIC ONTO THE RAIL

Your order will arrive with a filler strip attached onto the bottom pleat of the fabric stack. Slide the filler strip into the fabric grooves on the rail.

Fan out the fabric and slide the metal strip onto the rail, as shown. Center the arch. If the installation is a stand-alone outside mount, insert end caps onto the ends of the rail.

INSTALL ARCH CENTER

A plastic circle matching your headrail color is provided to prevent light leak and complete the decorator look of your specialty pleated shade. The plastic circle is scored in quarters with pressure sensitive tape on the back for easy installation. Snap plastic circle in halves and attach to headrail (a plastic half can be attached to both inside and outside of shade).

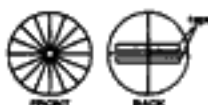

CONTINUOUS CORD LOOP SHADE

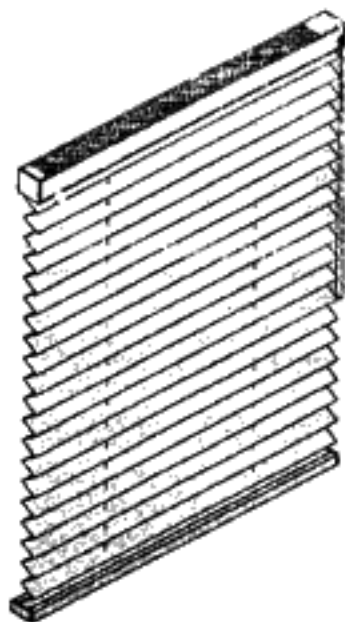

INSTALLING BRACKETS

INSIDE MOUNT APPLICATIONS

For inside mounting of the shade, attach the tops of the installation brackets to the top sill of the window opening. To fully recess the shade, the flat surface of the sill must be at least 1-1/4" deep. Add to this minimum depth requirement the dimension of any obstruction to shade movement, such as a window crank or handle.

Two screws are needed to attach each bracket. Position the brackets so that their front edges are aligned.

INSIDE MOUNT

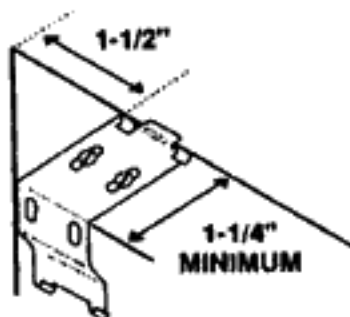

OUTSIDE MOUNT APPLICATIONS

Mount the ends of the installation brackets on a flat vertical surface at least 3/4" high. Two screws are used to attach each bracket. Position the brackets so that their tops are on the same level and parallel to the top of the window opening.

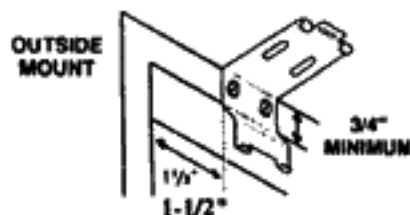

INSTALLING THE SHADE

Unwind the cord from around the shade assembly and let it hang. With the front of the shade facing you, slip the headrail into the bottom of the headrail into the bottom groove on the brackets, making sure no fabric gets trapped between the headrail and the bracket. then push on the rail until the top groove snaps into place, as shown.



SHADE OPERATION

Lower the shade by pulling on one side of the cord loop, and raise it by pulling on the other side. After lowering the shade all the way, the shade will raise if you continue to pull the cord in the same direction.

If your shade ever gets out of alignment (tilted), lower the shade by pulling on one side of the cord loop and raise it by pulling on the other side.

PLEATED SKYLIGHT SHADE WITH SUPPORT CORD

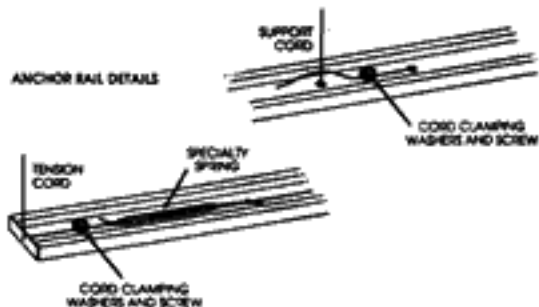
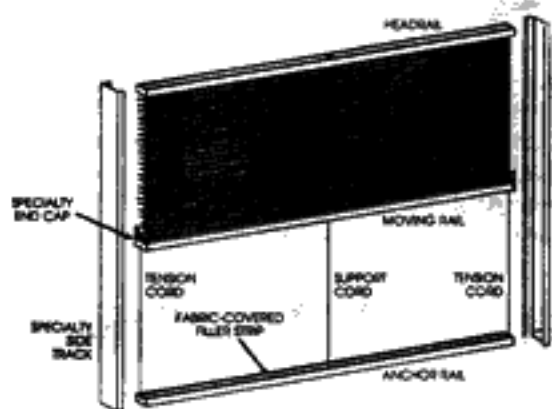

INSTALL ARCH CENTER

A plastic circle matching your headrail color is provided to prevent light leak and complete the decorator look of your specialty pleated shade. The plastic circle is scored in quarters with pressure sensitive tape on the back for easy installation. Snap plastic circle in halves and attach to headrail (a plastic half can be attached to both inside and outside of shade).

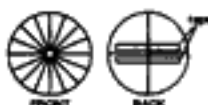

CONTINUOUS CORD LOOP SHADE

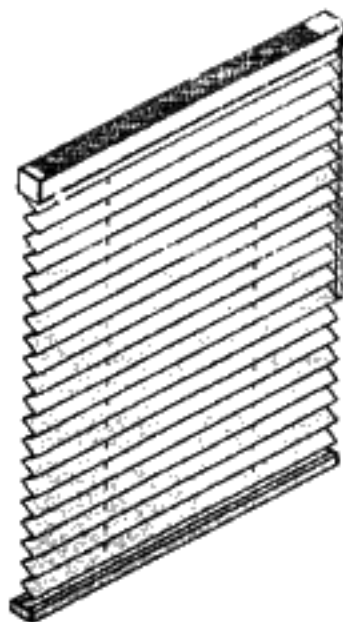

INSTALLING BRACKETS

INSIDE MOUNT APPLICATIONS

For inside mounting of the shade, attach the tops of the installation brackets to the top sill of the window opening. To fully recess the shade, the flat surface of the sill must be at least 1-1/4" deep. Add to this minimum depth requirement the dimension of any obstruction to shade movement, such as a window crank or handle.

Two screws are needed to attach each bracket. Position the brackets so that their front edges are aligned.

INSIDE MOUNT

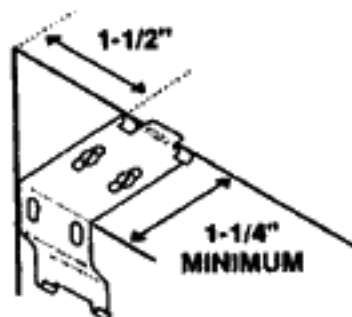

OUTSIDE MOUNT APPLICATIONS

Mount the ends of the installation brackets on a flat vertical surface at least 3/4" high. Two screws are used to attach each bracket. Position the brackets so that their tops are on the same level and parallel to the top of the window opening.

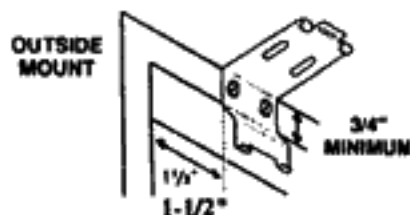

INSTALLING THE SHADE

Unwind the cord from around the shade assembly and let it hang. With the front of the shade facing you, slip the headrail into the bottom of the headrail into the bottom groove on the brackets, making sure no fabric gets trapped between the headrail and the bracket. then push on the rail until the top groove snaps into place, as shown.



SHADE OPERATION

Lower the shade by pulling on one side of the cord loop, and raise it by pulling on the other side. After lowering the shade all the way, the shade will raise if you continue to pull the cord in the same direction.

If your shade ever gets out of alignment (tilted), lower the shade by pulling on one side of the cord loop and raise it by pulling on the other side.

PLEATED SKYLIGHT SHADE WITH SUPPORT CORD

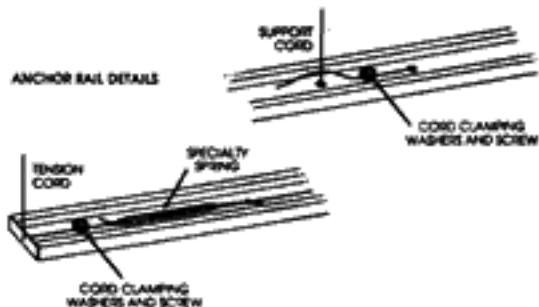
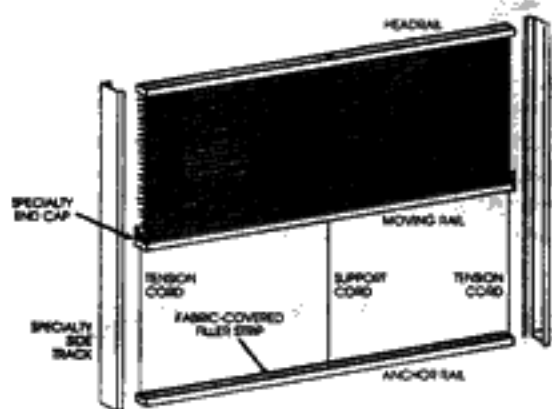

INSTRUCTIONS

1. Mount the specialty side tracks in the area the shade is to be mounted.
2. Mount the brackets (standard brackets).
3. Place the shade into the sidetracks. This can be done by inserting the shade at an angle on the top and the bottom.
4. After the shade is in the side tracks, the shade may be mounted into the brackets.

SAFETY

NOTICE: This shade has been made according to methods endorsed and recommended by the Consumer Product Safety Commission and utilizes a single cord below the cord stop to reduce the possibility of accidental strangulation.

WARNING: When shade is raised, a loop will appear above the cord stop. Keep out of reach of children.

WARNING

To avoid possible strangulation, keep cords out of the reach of children. Use these devices:

1. Clamp or clothes pin
2. Cleat
3. Tie the cord to itself
4. Tie-down device



CLEANING INSTRUCTIONS

Lay shade out on a clean flat surface. If the shade is dusty, simply vacuum over it using an upholstery attachment. For cleaning soiled spots on shade, we recommend using an aerosol spray foam upholstery or fabric cleaner. Spray the foam cleaner over the area to be cleaned. Immediately scrub the area with a clean, damp sponge (back and forth gently in a direction parallel to the pleats in the fabric) until the stains are removed. Be careful not to crush or wrinkle the fabric. Remove the cleaner from the fabric with a damp sponge. We do not recommend soaking or submerging the entire shade in water. Remove the excess water from the fabric by patting with a clean dry towel. Hang the shade up when dry. Frequent or repeated cleaning may tend to remove the fullness and body of the pleated fabric.